

Caratteristiche tecniche - Credenze e contenitori con struttura e base in massello di noce americano. Ante, fianchi e frontali cassetti rivestiti in ebano, tessuto, pelle o laccati. Disponibile versione extra con ante, fianchi e frontali cassetti rivestiti con strisce in massello di noce americano. Interno credenza con n°1 mensola in vetro trasparente in ogni scomparto. Interno contenitori con n°2 mensole in vetro trasparente in ogni scomparto. Piano in legno, vetro colorato o marmo.

Technical features - Sideboards and cabinets with structure and base in solid American walnut. Doors, side panels and drawer fronts covered in ebony, fabric, leather or lacquered. Available the version extra with doors, side panels and drawer-fronts covered with strips in solid American walnut. Internal of sideboards with n°1 transparent glass shelf in each compartment. Internal of cabinets with n°2 transparent glass shelves in each compartment. Top in wood, colored glass or marble.

Nota - Specificare la finitura del legno, tra quelle presenti a campionario. Per la finitura laccato specificare il colore NCS o RAL. Se non specificato, il top viene considerato in legno di noce americano, nella finitura scelta per la struttura del mobile.

Note - To specify NCS or RAL color for lacquered version. If not specified consider the finish of the top in American walnut, in the same color chosen for the cabinet frame.

Full alto 2 ante / high 2 doors

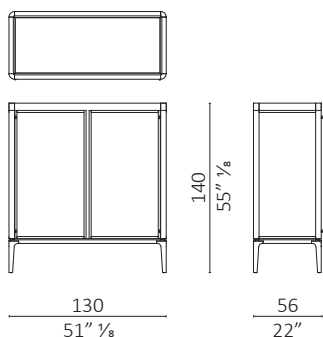

c.o.m. (l.mt.2,50/sq.mt.3,60)
volume m³ 1,875 - **kg.** 167

Full alto 3 cassetti DX / high 3 drawers RH

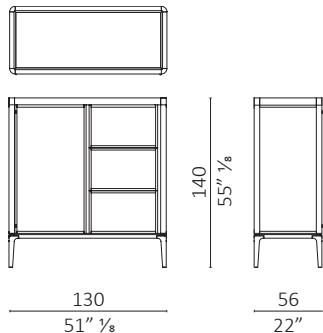

c.o.m. (l.mt.2,70/sq.mt.4,00)
volume m³ 1,875 - **kg.** 172

Full alto 5 cassetti DX / high 5 drawers RH

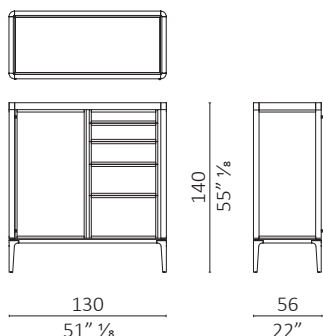

c.o.m. (l.mt.2,70/sq.mt.4,00)
volume m³ 1,875 - **kg.** 180

Full alto 3 cassetti SX / high 3 drawers LH

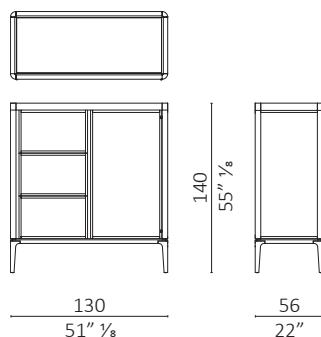

c.o.m. (l.mt.2,70/sq.mt.4,00)
volume m³ 1,875 - **kg.** 172

Full alto 5 cassetti SX / high 5 drawers LH

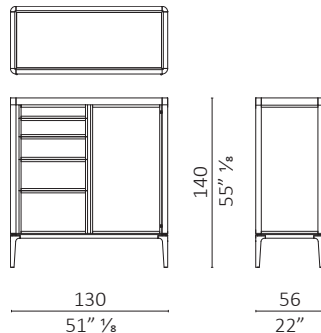

c.o.m. (l.mt.2,70/sq.mt.4,00)
volume m³ 1,875 - **kg.** 180

Full alto mix 3 cassetti / high mix 3 drawers

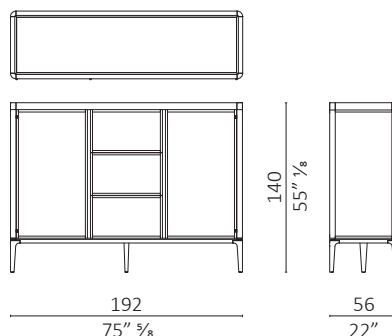

c.o.m. (l.mt.3,50/sq.mt.5,00)
volume m³ 2,805 - **kg.** 202

Full alto mix 5 cassetti / high mix 5 drawers

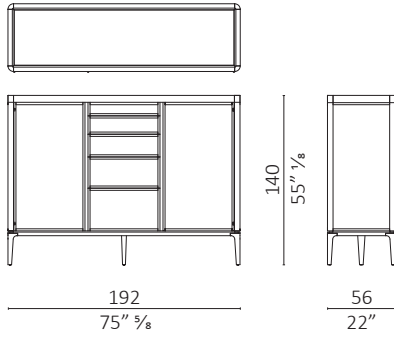

c.o.m. (l.mt.3,50/sq.mt.5,00)
volume m³ 2,805 - kg. 202

Full basso 4 ante / low 4 doors

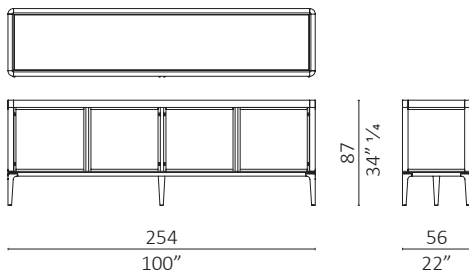

c.o.m. (l.mt.2,50/sq.mt.5,00)
volume m³ 2,506 - kg. 203

Top

Caratteristiche tecniche - Piano in marmo o in vetro colorato NCS/RAL in alternativa al piano in legno.

Technical features - Marble or NCS/RAL coloured glass top in alternative to wooden top.

Full basso 3 ante / low 3 doors

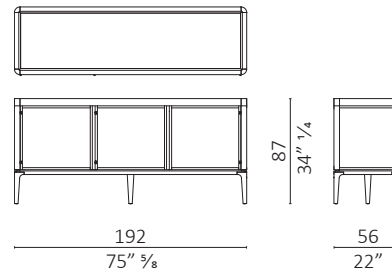

c.o.m. (l.mt.2,50/sq.mt.4,00)
volume m³ 1,908 - kg. 161

Full basso 3 cassetti / low 3 drawers

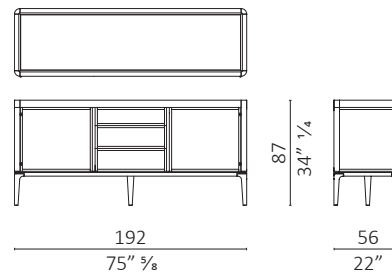

c.o.m. (l.mt.2,50/sq.mt.4,00)
volume m³ 1,908 - kg. 168

Accessori / Accessories

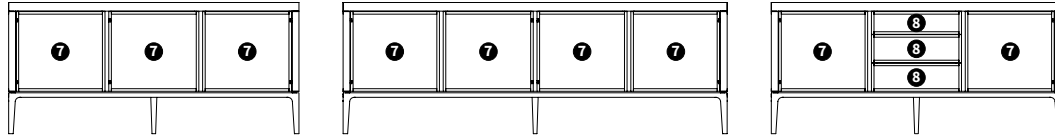
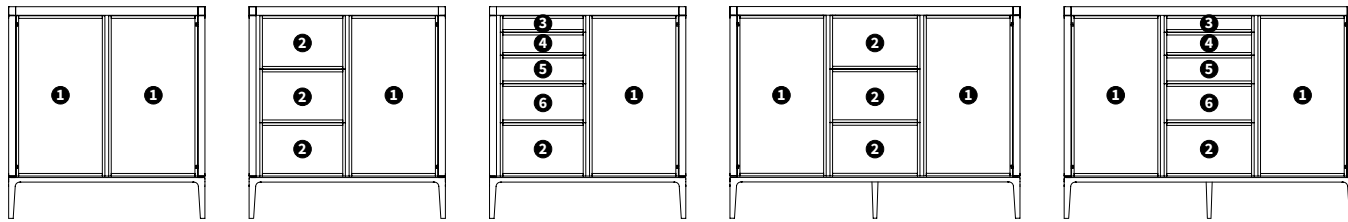

Divisorio 6 / Partition 6 - H 7,5

Caratteristiche tecniche - Divisorio cassetto in ebano.
Technical features - Internal drawer partition in ebony.



3

Divisorio 2 / Partition 2 - H 10

Caratteristiche tecniche - Divisorio cassetto in ebano.
Technical features - Internal drawer partition in ebony.

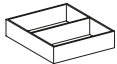

2 5 6

Bicchieri / Glasses

Caratteristiche tecniche - Divisorio cassetto in ebano.
Technical features - Internal drawer partition in ebony.



4

LED per 1 scomparto / for 1 compartment

Caratteristiche tecniche - Luce LED con accensione all'apertura dell'anta.
Technical features - LED light with door opening control.



1 7

Divisorio 3 / Partition 3 - H 6,5

Caratteristiche tecniche - Divisorio cassetto in ebano.
Technical features - Internal drawer partition in ebony.

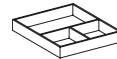

4 8

Porta bottiglie / Mini bottle - H 6,5

Caratteristiche tecniche - Divisorio cassetto in ebano.
Technical features - Internal drawer partition in ebony.

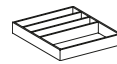

2

Bicchieri / Glasses

Caratteristiche tecniche - Divisorio cassetto in ebano.
Technical features - Internal drawer partition in ebony.

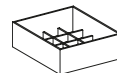

2

Vassoio / Tray

Caratteristiche tecniche - Vassoio in ebano.
Technical features - Tray in ebony.

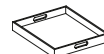

2

Porta gioielli / *Jewelry box*

Caratteristiche tecniche - Porta gioielli rivestito in pelle.
Technical features - Jewelry box covered in leather.

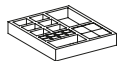

4

Scarpiera / *Shoerack*

Caratteristiche tecniche - Ripiano estraibile per scarpe in noce americano con battitacco e maniglia in ottone brunito.
Technical features - Pull-out shoe shelf in American walnut with burnished brass shoe support strip and handle.

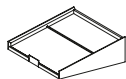

1

Frigo 40 L / *Fridge 40L*

Caratteristiche tecniche - Frigo rivestito in legno.
Technical features - Fridge covered in wood.

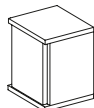

1

Mensola estraibile / *Pull-out shelf*

Caratteristiche tecniche - Mensola estraibile con piano in pelle.
Technical features - Pull-out shelf with top in leather.

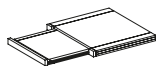

1

Cassettiera interna / *Internal drawer unit*

Caratteristiche tecniche - Cassettiera interna per credenza.
Technical features - Internal drawer unit for sideboard.

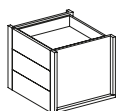

7

Porta sigari / *Cigar box*

Caratteristiche tecniche - Scatola porta sigari con interni in legno di cedro.
Technical features - Cigar box with internal in cedar wood.

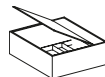

2

Kit pulisci scarpe / *Box for shoe cleaning kit*

Caratteristiche tecniche - Scatola per kit pulisci scarpe.
Technical features - Box for shoe cleaning kit.

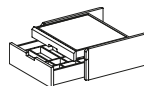

1

Frigo 20 L / *Fridge 20L*

Caratteristiche tecniche - Frigo rivestito in legno.
Technical features - Fridge covered in wood.

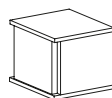

7

Cassetto interno / *Single drawer undertop*

Caratteristiche tecniche - Cassetto interno sottopiano.
Technical features - Under top single drawer.

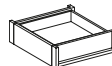

1 7

Cassettiera interna / *Internal drawer unit*

Caratteristiche tecniche - Cassettiera interna per contenitore.
Technical features - Internal drawer unit for cabinets.

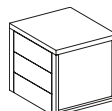

1

Porta documenti / *Document holder*

Caratteristiche tecniche - Porta documenti per cassetto.
Technical features - Document holder for drawer.

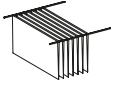

2

Pannello interno / *Internal panel*

Caratteristiche tecniche - Pannello interno posteriore in tessuto.
Technical features - Internal back panel in fabric.
Nota - Valido sia per il contenitore che per le credenze.
Note - Available for both cabinet and sideboards.

Fondo cassetto / *Drawer bottom*

Caratteristiche tecniche - Fondo cassetto in pelle.
Technical features - Bottom of drawer in leather.

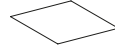

2 3 4 5 6 7 8

Mensola in vetro / *Glass shelf*

Caratteristiche tecniche - Mensola interna in vetro.
Technical features - Internal glass shelf.

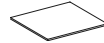

1 7

Finiture / *Finishes*

Legno Noce / *Wood Walnut*



Noce
Walnut



Noce dark
Walnut dark



Noce moka
Walnut moka

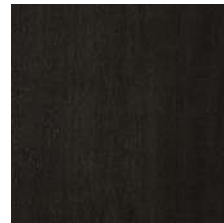

Noce brown
Walnut brown

Legno Ebano / *Wood Ebony*



Ebano
Ebony

Finiture / Finishes

Laccato / Lacquered

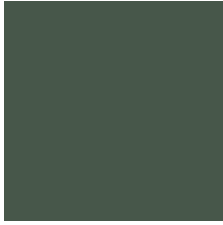

NCS S7010G10Y

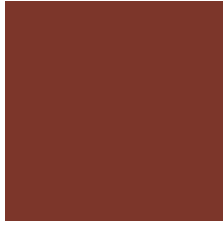

NCS S5040Y80R



NCS S3502Y

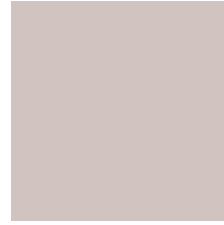

NCS S2010R



NCS S3030Y10R



NCS S6010R90B

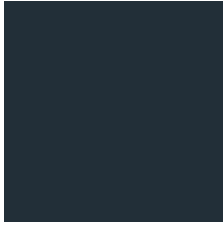

NCS S8010R90B



NCS S3005Y50R

Marmo / Marble



Stazzema

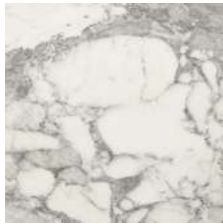

Cervairole



Calacatta
Calacatta Oro



Arabescato

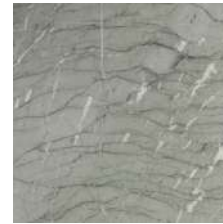

Verde Mediterraneo



Portoro

Tessuto Raso / Fabric Satin

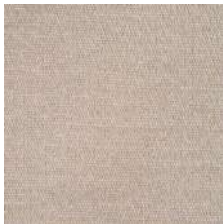

Cendrillon-006 Perle



Cendrillon-014 Rose
Thè



Cendrillon-005 Gres

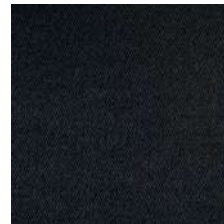

Cendrillon-010 Orage



Cendrillon-023 Olive



Cendrillon-012
Moutarde



Cendrillon-030 Pirate

Finiture / Finishes

Pelle / Leather Color Sphere PF



SC 06 Calicot



SC 23 Tortora



SC 32 Caolino



SC 51 Panna



SC 31 Quarzo Fumè



SC 34 Maggese

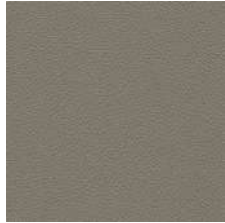

SC 26 Topo

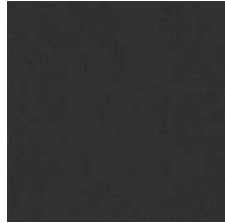

SC 20 Inchiostro

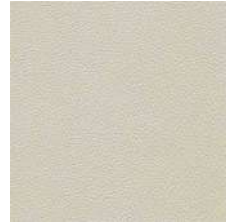

SC 21 Amianto

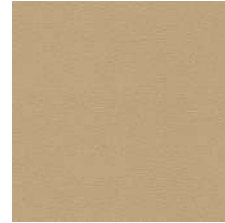

SC 53 Creta



SC 55 Camel Hair

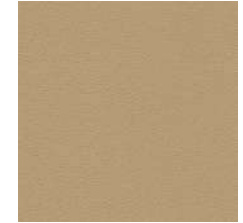

SC 52 Daino



SC 66 India



SC 59 Noce di Pecan



SC 80 Bruno Havana



SC 29 Ardesia



SC 148 Lacca



SC 146 Coccio Pesto



SC 173 Glauco



SC 177 Limo



SC 178 Alpi



SC 254 Steel Blue



SC 278 Atlantic Blue



SC 279 Alchemy

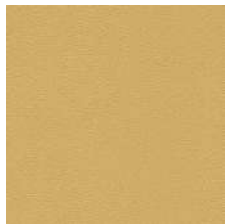

SC 133 Paglierino